

¹Anjanaa DHRITLAHRE, ²Anu G. PILLAI

REDUCTION OF VOLTAGE SAG USING SRF THEORY CONTROL BASED DVR FOR POWER QUALITY ENHANCEMENT

^{1,2}Department of Electrical Engineering, College of Shri Sankaracharya Group of Institution Bhilai, University of CSVTU Bhilai, INDIA

Abstract: To make developed country, recent year India shift towards the research area for the development to lead the research. The main task of power system is to supply their customer a continuity power supply at ever, but in action it's not take place; because of the whole power system is the big network which includes different types of loads, at the instant of common compiling sensitive loads connected in which voltage distortion in supply side or load side is highly repellent. Voltage dip is the most frequent arising power quality issues mainly occurs in distribution system since it main causes disturbance for domestic and industrial equipment. In this paper the simulink model of DVR for reduction of voltage sag and its control by reference frame theory algorithm has carried in MATLAB simulink to enhance the power quality issues

Keywords: Power Quality, Voltage Sag, THD, DVR, Park Transformation, SRF Theory

INTRODUCTION

Electrical power system, power quality is extensive term to describe the effectiveness and its performances. Modern society goes to progress area and they interest not only the supply of power, but also the consistent and good quality of power supply hence reliability of system and quality of power this two is the most essential phrase of any power system, we know that assortment of the entire electric network modules in power system is related to generate the energy and this valuable energy transmit, distribute and utilize by different consumers according to their obligation. This complex network hundreds of generating location and loads center are unified, the power are primarily generated at power station and this power transmitted over long distance to a load center usually cities or towns and there are lots of way in which the lack of power quality difficulty affect consumers [1].

There can be absolutely different definitions for power quality “Any power difficulty manifested in voltage, current, or frequency deviations that outcome in collapse or misoperation of consumer equipment.” Or power quality is a set of electrical restrictions that allow a part of apparatus to function in its proposed manner without the hammering of existences. [2-3].

Power quality problems include variety of trouble in the vein of voltage sag, swell, outage, voltage unbalances, flickers, harmonics, etc. out of this due to some faults voltage sag/swell frequently occurring power problems, harmonics distortion can harmful collision in a capable electric distribution system and can generate excessive amounts of heat causes collapse and failure. This entire power problem can affect the precision of utility gauge analysis, malfunctioning of equipments, and downtime and damage consequential loss of production [4]. In this

paper synchronous reference frame (SRF) theory control algorithm based DVR is used to enhance the power quality problem, DVR is costume power device connected in series for the compensation of voltage related power quality issues hence reduction of voltage sag and harmonics present load side due to nonlinear load this device is used.

OPERATION AND WORKING OF DVR

The power quality problem begin within the site of common coupling due to the voltage fall in feeders and transformers, different kind of trouble, faults, use of nonlinear loads, etc affects the consumer. “Voltage sag is the incessantly arise conflict i.e. 10 to 90% for the short duration or 0.5 cycle, and to compensate voltage quality issues dynamic voltage restorer (DVR) is used.”

Figure1 shows the DVR connected in feeder-2 in this parallel distribution feeder, when fault occurred in distribution feeder-1, voltage at feeder-2 will sag, without connection of DVR loss of production in power, failure and malfunctioning of equipment and consumer face the problems. DVR is the series allied apparatus; connect between distribution transformer and perceptive loads by revenue of security. Series compensator are used for both inject the voltage of essential magnitude and frequency or restorer the voltage across the load to save from harm the sensitive loads.

DVR used metal oxide semiconductor field effect transistor based pulse width modulation to inject the same and conflicting voltages of disorder to protect and uncontaminated synchronized voltage waveform crossways the sensitive loads. The waveform of injected voltage is variable, for production of varying voltage, PWM converters would require, DVR also consist low cost rectifier to support the dc bus can emulate the series line voltage to avoid the voltage dip[5-6].

Figure 2 shows the phasor diagram of voltage injection scheme of DVR, ‘VL’ (Pre-sag) is the voltage across the sensitive load at sag condition, for the duration of sag situation voltage reduce to ‘Vs’ at angle of θ . According to the phase angle of the load voltage, the injection of voltages can be realized; in phase with the supply voltage VC1 represents the voltage injection. With the injection of VC2, the magnitude of load voltage remains same, but it leads supply voltage Vs by a small angle. In VC3, the load voltage retains the same phase as that of the pre-sag condition [7].

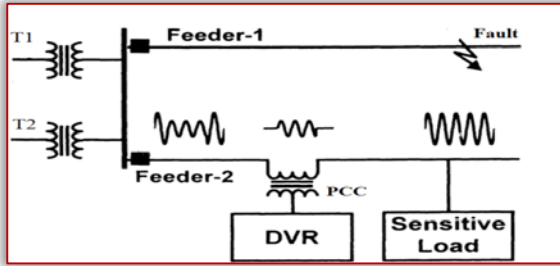

Figure 1. Connection of DVR to reduce voltage sag.

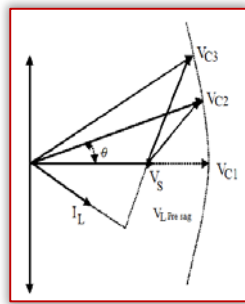

Figure 2. Phasor diagram of voltage injection scheme for DVR.

CONTROL ALGORITHM OF DVR

The control algorithm of DVR is the based on evaluation of reference load voltage for power quality enhancement in distribution system.

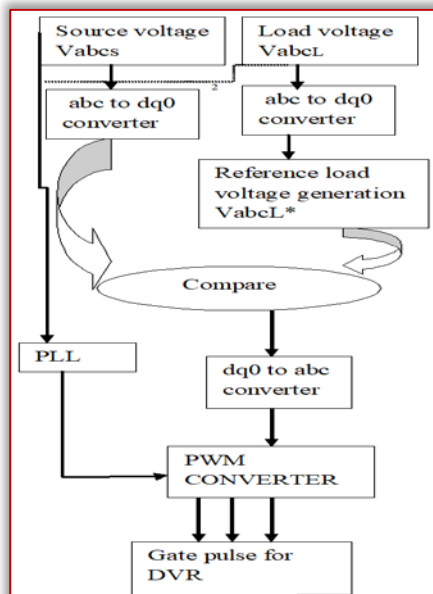

Figure 3. Flowchart of Control Algorithm of DVR

Figure 3 shows the flowchart of control algorithm of DVR in which estimation of voltage sag; synchronous reference frame theory is used. ‘In synchronous reference frame theory the voltage (Vs) at the position of common coupling, and the terminal load voltage (VL) sensed to derive the MOSFET gate signal. The reference load voltage (V_{abcL}^*) are extracted using the consequent unit vector.

The amplitude of load voltage at the spot of common coupling is deliberate as

$$V_L = \sqrt{2/3(V_{La}^2 + V_{Lb}^2 + V_{Lc}^2)} \quad (1)$$

Unit vector is calculated as

$$\begin{bmatrix} U_a \\ U_b \\ U_c \end{bmatrix} = 1/V_L \begin{bmatrix} V_{La} \\ V_{Lb} \\ V_{Lc} \end{bmatrix} \quad (2)$$

Where V_{La}, V_{Lb}, V_{Lc} is the load voltage.

Now reference load voltage are calculated as

$$\begin{bmatrix} V_{aL}^* \\ V_{bL}^* \\ V_{cL}^* \end{bmatrix} = V_L^* \begin{bmatrix} U_a \\ U_b \\ U_c \end{bmatrix} \quad (3)$$

Where V_L^* is the reference value of magnitude of the load Voltage?

The load voltage is converted into the reference voltage by using of abc-dq0 adaptation using park transformation with unit vector derivative with the help of phase locked loop [8].

Park transformation is derived as:

$$\begin{bmatrix} V_{Ld} \\ V_{Lq} \\ V_{Lz} \end{bmatrix} = \frac{2}{3} \begin{bmatrix} \sin \omega t & \sin(\omega t - 2\pi/3) & \sin(\omega t + 2\pi/3) \\ \cos \omega t & \cos(\omega t - 2\pi/3) & \cos(\omega t + 2\pi/3) \\ 1/2 & 1/2 & 1/2 \end{bmatrix} \begin{bmatrix} V_{La} \\ V_{Lb} \\ V_{Lc} \end{bmatrix} \quad (4)$$

Similarly the reference voltage and source voltage at PCC is also renewed into the abc-dq0. Now the DVR voltage is achieve as

$$\begin{aligned} V_{Cd} &= V_{ds} - V_{dL} \\ V_{Cq} &= V_{qs} - V_{qL} \end{aligned}$$

Reference DVR voltage are obtain as

$$\begin{aligned} V_{Cd}^* &= V_{dr} - V_{dL} \\ V_{Cq}^* &= V_{qr} - V_{qL} \end{aligned}$$

The DVR voltage as the fame of ‘abc’ is obtain by using reverse park transformation

$$\begin{bmatrix} V_a \\ V_b \\ V_c \end{bmatrix} = \begin{bmatrix} \sin \omega t & \cos \omega t & 1 \\ \sin(\omega t - 2\pi/3) & \cos(\omega t - 2\pi/3) & 1 \\ \sin(\omega t + 2\pi/3) & \cos(\omega t + 2\pi/3) & 1 \end{bmatrix} \begin{bmatrix} V_d \\ V_q \\ V_z \end{bmatrix} \quad (5)$$

This DVR voltage is use in the PWM controller to generate the gate signal, PWM controller works with the constant switching frequency. Phase lock loop is an electronics path consisting of a phase detector that evaluates the phase of signal with the phase of input signal to maintain the phase coordinated.

SIMULINK MODEL

Simulink model for test system considers in which two parallel feeder are cleared show in Figure4a In this model the three-phase to ground fault and double line to ground fault is created in feeder-1 at the duration

of 0.15 sec (0.4sec to 0.55 sec) and Figure 4b shows the simulink model of test circuit with a dynamic voltage restorer connected in feeder-2.

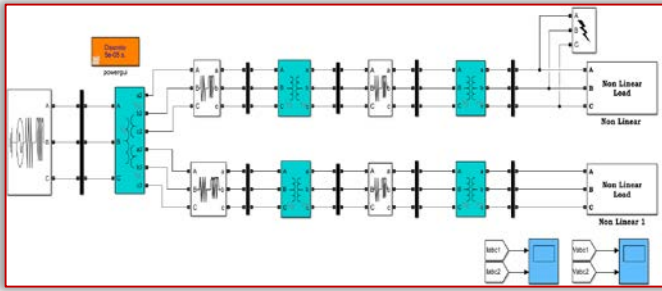

Figure 4a. Simulink model of test system without custom power device

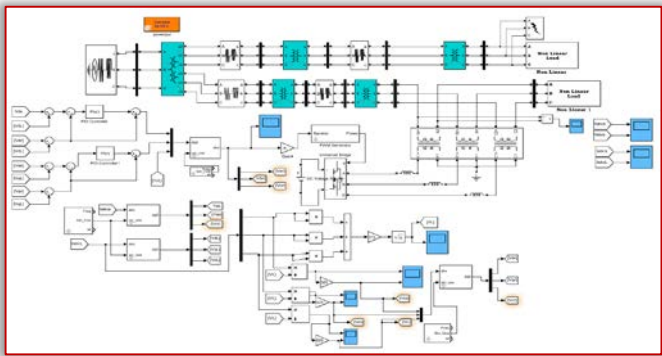

Figure 4b. Simulink model of SRF control based DVR for reduction of voltage sag.

RESULT AND DISCUSSION

Dynamic voltage restorer is the piece of equipment used for the reduction of a different power quality issues, reference theory control algorithm is used to control of DVR in manner to inject the required control voltage for voltage sag alleviation. In Simulink model the three phase to ground fault is created in f-1 sag is automatically occurred in adjacent feeder-2 shows Figure 5a.

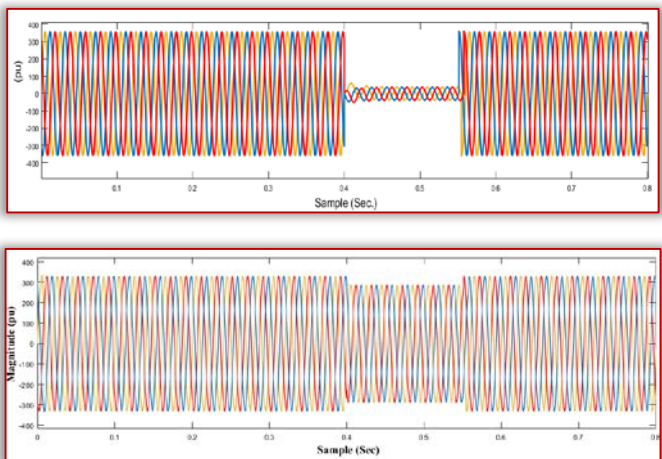

Figure 5a. 1) Load voltage where three phase to ground Fault occurred, 2) Load voltage of adjacent feeder. To overcome this power quality problem (voltage sag) SRF control algorithm based control of DVR is used. The performance of the DVR is demonstrated under the supply voltage Figure 4b shows the performance of

DVR under voltage sag condition, when fault created in parallel feeder-1 for the duration of 0.15sec, at the same duration the voltage sag involuntarily occurred in adjacent feeder-2. The source voltage, load voltage, voltage injected by DVR, The reference voltage (V_L^*), dc bus voltage are depicted in Figure 5b.

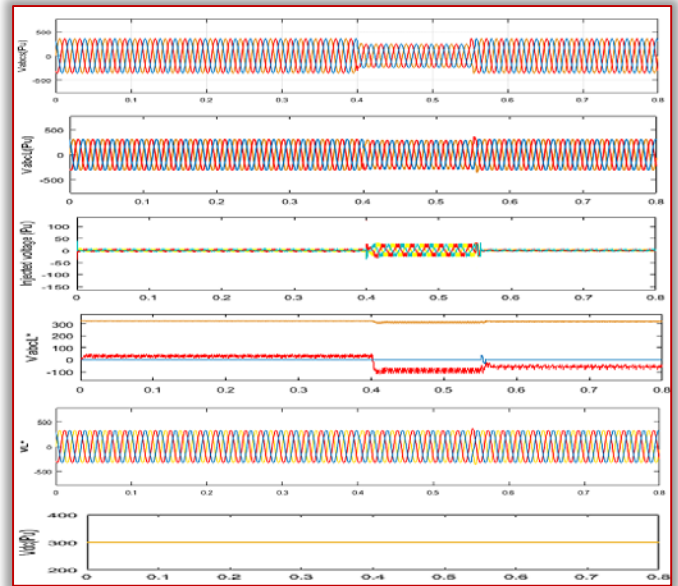

Figure 5b. Performance characteristics of SRF control based DVR for voltage sag when three phase to ground fault occurred.

DVR with its control algorithm is connected in feeder-2 between the distribution transformer and the load. All the parameter for the three phase parallel distribution system data specified in appendix A. The load voltage is maintained sinusoidal by injected the recompense voltage of DVR. DC bus voltage is persistent constant at the value of 300 volt and terminal voltage is at is practical at the reference value according to the peak value of source voltage. The performance of total harmonics distortion at the fundamental frequency of (50Hz) also carried in Figure 5c the THD for the 20 cycle out of 40 cycles is observed 2.69%.

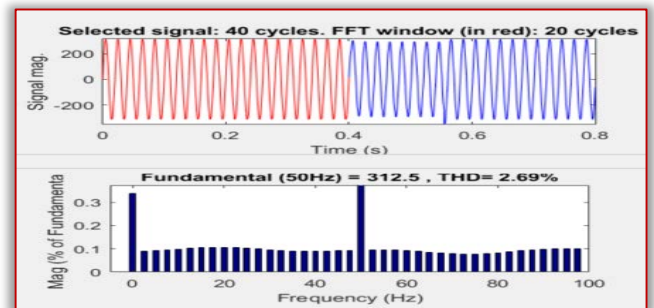

Figure 5c. The performance of harmonic by FFT analysis. Figure 5d shows the load voltage where double line to ground fault occurred in feeder 1, the voltage sag automatically occurred in adjacent feeder at the same duration, source voltage , load voltage, injected voltage are depicted in Figure 5e.

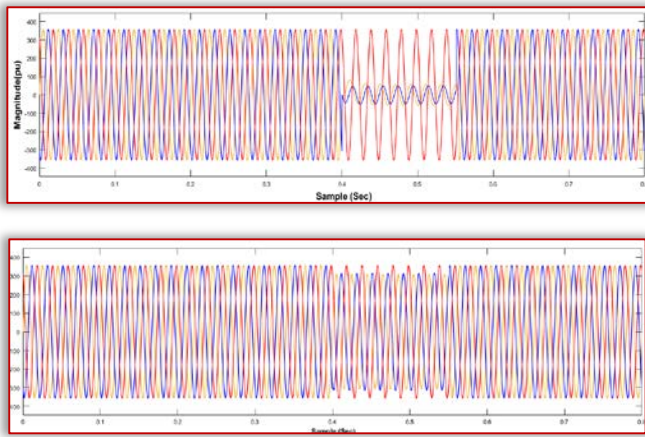

Figure 5d. 1) load voltage where double line to ground fault occurred; 2) load voltage at adjacent feeder.

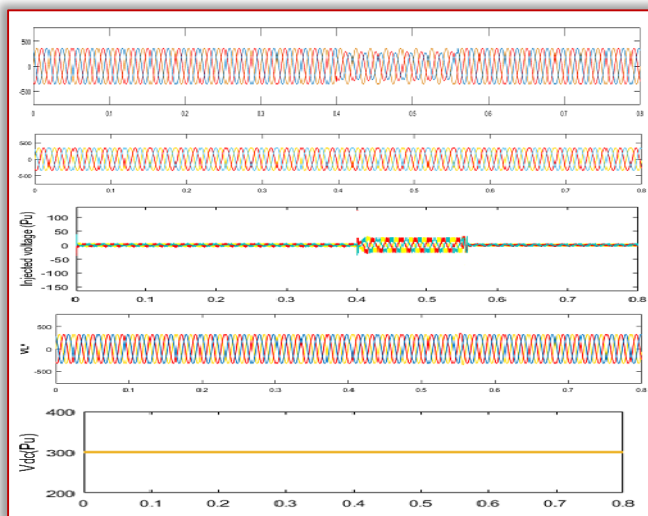

Figure 5e. Performance characteristics of SRF control based DVR for voltage sag when double line to ground fault occurred.

The performance of for voltage sag mitigation is shown where the source voltage for DVR is consider 440 volt whose peak value is obtain as: $V_{peak} = 440 \times 0.8 = 352$ volt. Hence the reference load voltage (V_L^*) is obtain according to this peak value of the source voltage, all this performance the voltage sag reduced and power quality can be enhanced.

CONCLUSION

The increasing use of sensitive loads power quality problem and its mitigation to enhance power problem today its most important research area. Voltage sag is the frequently stirring power problem manifested in consumer load side. DVR is the series connected custom power device use for the reduction of voltage related disturbances and effective device for sensitive load. The simulation result shows that voltage sag is compensated with the permissible THD with the help of DVR. SRF control technique is used to control the DVR to obtain an injected voltage, with the help of park transformation the reference voltage is calculated and to generate a gate pulse the PWM controller is used and to maintain a phase

coordination between input and output the phase lock loop is required. All this performance condition is demonstrated in MATLAB simulink.

Appendix

- # The parameter consider for test system: Ac source feeder: 33kv, line frequency: 50Hz, Power transformer: 33/66kv, Distribution transformer: 33e3/440 volt, consumer load: single phase bridge rectifier with $R = 6 \Omega$, $L = 0.15e-3H$.
- # The parameter for the DVR Source voltage: 440 volt frequency 50 Hz, PCC Transformer Ratio: 1:3 ,DC bus: 300 volt, inductance $L = 0.008H$.

List of Abbreviation

- # SRF - Synchronous reference frame
- # PWM - Pulse width modulation
- # DVR - Dynamic voltage restorer
- # PCC - Point of common coupling
- # MOSFET - Metal oxide semiconductor field effect transistor

References

- [1] Arindam Gosh and Gerard Ledwich, “Power Quality Enhancement using Custome Power Devices”, Kluwer Academic Publishers group Dordrecht, 2002.
- [2] Roger C. Dugen and Surya Santoso, “Electrical Power System Quality” MC Grow Hill componie, 2004.
- [3] C. Sankaran, “Power Quality” CRC Press Boca Raton London New York Washington, 2002, ch.-1.
- [4] Kusko, Marc T.Thompson, “Power Quality In Electric System”, Mc Grow Hill Componie New York, 2007. DOI: 10.1036/0071470751. Ch. 3,8,10.
- [5] Mohammad Imran, S.M.Kulkarni, “Dynamic Voltage Restorer for Mitigation of Voltage Sag and Swell”, International Conference on Energy, Communication, Data Analytics and Soft Computing (ICECDS-2017), Pp. 3333-3335.
- [6] Amir Hameed Abed, Javad Rahebi, Ali Farzamnia, “Improvement for Power Quality by using Dynamic Voltage Restorer in Electrical Distribution Networks”, IEEE-2017, 2nd International Conference on Automatic Control and Intelligent Systems (I2CACIS 2017), 21 October 2017, Kota Kinabalu, Sabah, Malaysia, Pp. 122-127.
- [7] Prasad A. Raut, Manohar N. Kalgunde, “An Overview And Design Of Dynamic Voltage Restorer To Improve Power Quality In Microgrid”, IEEE-2015 International Conference on Energy Systems and Applications (ICESA 2015) Dr. D. Y. Patil Institute of Engineering and Technology, Pune, India 30 Oct - 01 Nov, 2015, PP. 632-635.
- [8] J. Bangarraju, K Amritha, “Unit Vector Of SRF Control Algorithm Based DVR For PQ Improvement”, IEEE-2017 international conference on smart technology for smart nation. Pp. 1160-1165.
- [9] Bhim singh, ambrish chanda, “Power Quality Problem And Mitigation Techniques”, john wiley and son ltd 2015, first addition.