



¹.D. RAJENTHIRAKUMAR, ².R. SRIDHAR, ³.S. ASHOK KUMAR

FORWARD MICRO EXTRUSION OF MICRO PARTS AND STUDY OF EFFECTS OF GRAIN SIZE

¹⁻³. Department of Mechanical Engineering, PSG College of Technology, Peelamedu, Coimbatore – 641 004, Tamil Nadu, INDIA

Abstract: As demands on micro metal products increase significantly, micro forming becomes an attractive option in the manufacture of these products due to its advantages for mass production. Fundamental issues relating to materials, processes and analysis have been studied intensively in recent years and have been well documented in the literature. But still the application of metal forming to the manufacturing of micro parts is not widespread. One reason is that the knowhow of conventional forming cannot be simply transferred to the micro scale. Also the forming behavior mainly depends on the part's individual grain gathering leading to a rather unpredictable forming result and making a process design impossible. It has become essential to develop a proper understanding which in turn could be used to develop dedicated processes for the manufacturing of metallic micro components. In this work, an attempt has been made to realize this special application of metal forming. A novel experimental setup consisting of forward extrusion assembly and a loading set-up has been developed to obtain the force-displacement response. The effects of grain size on micro components and the material behavior during forward extrusion are investigated. Key issues observed while designing forward extrusion assembly and performing microextrusion process are discussed. The results indicate that the size, orientation and distributions of grains play an important part in the extrusion process.

Keywords: Micro extrusion, Grain size, Extrusion die, Deformation, Flow stress

INTRODUCTION

Micro manufacturing is becoming more and more important due to the recent trend of product miniaturization. Micro manufacturing technologies can be classified into two categories. One is the micro electromechanical system based lithography technologies and the other is the mechanically based micro manufacturing processes. Although the former is well-established for semiconductor and microelectronics, the same cannot be said to the latter, which includes micromachining, microinjection molding and micro forming. Among these four mechanically based processes, the first two have been relatively well-investigated. For microforming, however, it has not yet been systematically explored and studied. There are still many issues which need to be addressed [1-2]. Micro forming is the branch of manufacturing technology that deals with the fabrication of metallic micro parts. A micro part is concerned with small parts with typical part dimensions in the range of sub millimeters up to a few millimeters, although part-features may be in the micro range. The typical positional precision is expected to be in the range of 0.1 to 10 μm [3]. This paper addresses some of the key issues encountered by researchers worldwide on micro forming, specifically micro extrusion. An experimental set up for realization of forward micro extrusion is developed and the micro extrusions of aluminium and copper billets with different grain sizes are conducted. All the findings in this work are critical to further facilitate the development of micro formed parts.

LITERATURE SURVEY

Among different microforming processes, micro extrusion is widely investigated in terms of the effects of specimen size, grain size, the

formed part feature size, tooling workpiece interfacial friction and the forming temperature. Takatsuji et al. [4] investigated the friction behavior in the micro forward rod backward cup extrusion using aluminum alloy. Different coatings are applied on the tooling to study the friction effect. A similar study was conducted by Krishnan et al. [6] using brass. Their results, however, indicate that the coatings reduce the extrusion force and increase the length of the extruded pin. Different size scaled experiments on forward extrusion were conducted by Geiger and his colleagues [1, 6]. It is found that the punch pressure increases with the scaling down of the formed part size. A review on micro manufacturing and microforming can be found in Akhtar Razul Razali et al [7]. An intensive review on the latest development of microforming technologies is presented by M. W. Fu and W. L. Chan [8]. More recently micro gear extrusion of the high strength commercial aluminum alloy is performed by Xuehua Dong et al [9]. In their work, the effects of extrusion temperature, extrusion velocity and lubrication conditions on the formability, microstructure, and micro hardness of the aluminum alloy are studied. Based on the literature review, it can be noticed that different micro forming processes have been investigated independently and the focus is on a few factors in those studies. There is a lack of comprehensive research on different size effects in micro extrusion process. The objective of this work is to provide an in depth analysis on micro extrusion process in terms of the grain size.

EXPERIMENTAL ANALYSIS

In order to show the effects of minaturization and investigate the micro extrusion process, an experimental set-up is designed and micro

extrusion tests with aluminium and copper billets of different grain sizes have been conducted. In the following sections, the components of the experimental set up, the design process and the experimental results are presented.

Experimental Set-up

The experimental set up has four components: the micro-extrusion die, punch, the billet (work piece) and the press as shown in Figure 1. A computerized Universal Testing Machine (UTM) is found sufficient for micro extrusion process and the extrusion assembly is designed and dimensioned considering the same. This microprocessor based electromechanical machine designed with servo drive capable of testing mechanical behavior of metals and polymers. Table 1 gives the other important specifications of the machine. The extrusion dies used in the forward microextrusion experiments to determine the force-displacement response is shown in Figure 2.



Figure 1. Micro Extrusion Experimental Set Up

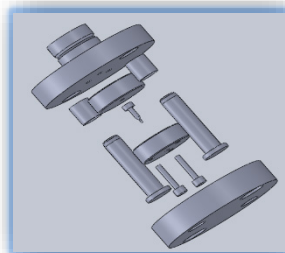

Figure 2. Micro Extrusion Die Assembly
Table 1. Micro Extrusion Machine: Specifications

No.	Parameter	Value
1	Load range	0-10 kN
2	Load measuring accuracy	± 2 % to 100% of load cell used
3	Maximum crosshead stroke	1000 mm (without grips and load cell)
4	Clearance between columns	450 mm
5	Crosshead displacement measurement	0.01 mm
6	Power supply	230 V AC, 50 Hz single phase

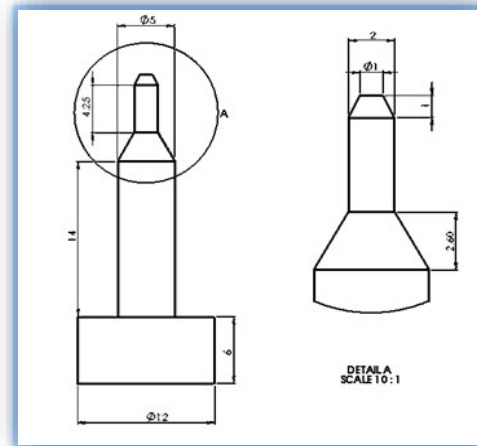

Figure 3. Micro Extrusion Punch Geometry

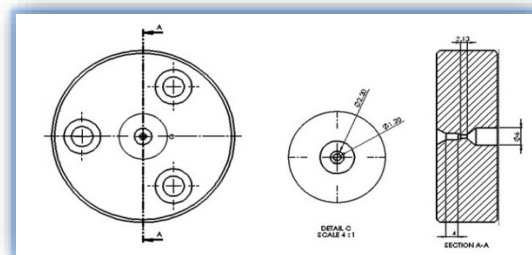

Figure 4. Die used for extrusion

The die assembly consists of an upper flange in which the punch holder and the punch are housed. This is guided into the die which is housed in the die holder which in turn is clamped on the lower flange. The lower flange is hosted by the UTM machine and the extrusion force is supplied by the upper flange. The punch and die geometry is given in Figure 3 and Figure 4 respectively.

Materials

Pure aluminium and copper billets are used in the experiments due to their wide applications in industry. The billets are cut from wires of 2 mm diameter. The average grain size of the selected copper is 38 μm. In terms of the experimental investigations it is important that the grain size of the material can be varied by heat treatment in a range of approximately 10 μm to 100 μm. The billets are exposed to heat treatment with different temperatures and working times to obtain different grain sizes. It is noticed that the grain size increases with the increase of working temperature and the grains are unevenly distributed in the billet. Specimens are also machined and finished by the highest possible accuracy. The final billets used in this work are given in Figure 5.



Figure 5. Aluminium and Copper billets (38 μm grain size)

RESULTS AND DISCUSSION

At first the experiments are conducted without lubrication at room temperature. In the second phase, machine oil is used as the lubricant and both the extrusion die and the billet are lubricated sufficiently. Experiments are conducted multiple times with both pure aluminium and copper billets. The micro parts produced are given in Figure 6. The following observations are made from the experiments:

- (i) the bending of the micro parts occurs when the overall length exceeds 5 mm
- (ii) to avoid 'bulging', the billet must be as straight as possible
- (iii) for ease of removal of formed parts the die surface has to be highly flat and uniform.

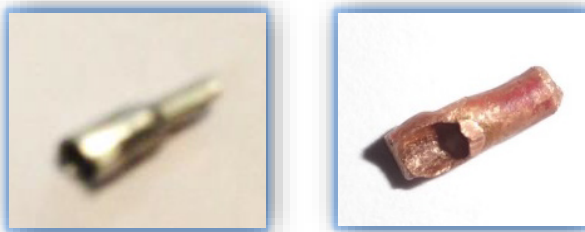

Figure 6. Micro Parts Made of Aluminium and Copper

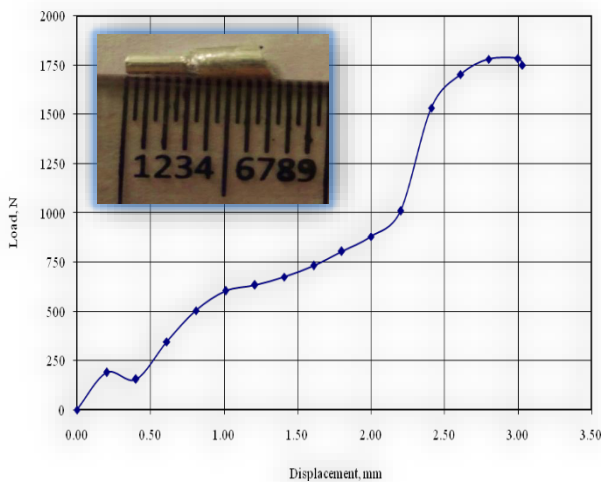

Figure 7. Load Vs Displacement Curve for Aluminium

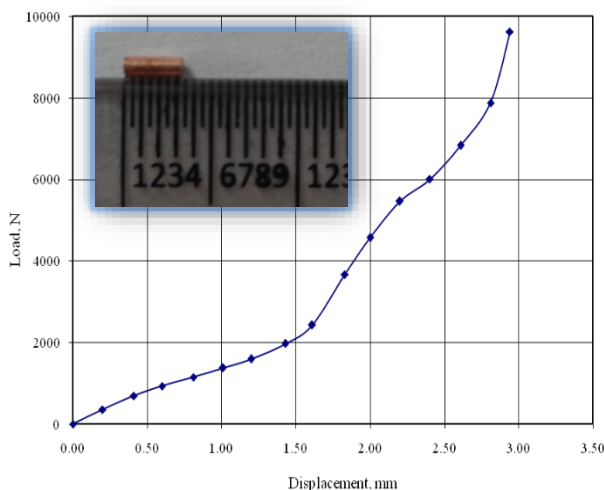

Figure 8. Load Vs Displacement Curve for pure Copper with out Heat Treatment

The load displacement curves for the experiments with pure aluminium billet are shown in Figure 7. It is found that aluminium can be extruded up to 3.6 mm with a peak load of 1750 N at 2.7 mm. The maximum flow stress of 567 N/mm² achieved at 3 mm. Pure copper (grain size = 38 μm) without heat treatment is first subjected to micro forward extrusion and the load versus displacement plot shown in Figure 8 is observed. It is noticed that the load versus displacement plot with extremely fine grains has a steeper slope. This is attributed to the strengthening effect.

Due to the presence of a large number of grain boundaries more than grain interiors, the hardness of the sample is higher and requires higher deformation load and flow stress. A linear relationship is observed between the load and the displacement up to 1.49 mm which indicates the material flow into the cavity opening of the die. From 1.49 mm to 2.48 mm, stable forward extrusion takes place as the sample is extruded from larger diameter region to smaller one. The sudden increase in the load is attributed to the shearing of the sample. Based on the experiments it is found that the maximum load is 9612 N which is achieved at a stroke length of 2.94 mm.

During second part of the experiment with pure copper heat treatment is done for two hours (grain size = 110 μm). Then the heat treated copper is subjected to micro forward extrusion and load versus displacement plot as shown in Figure 9 is obtained. As the number of grains per unit volume is decreased with the increase of grain size, the volume fraction of the grain boundary increases. Therefore, the grain boundary strengthening effects diminish gradually and further lead to the decrease of deformation load. The same trend is observed by Krishnan et al [5] during their experimental work.

Figure 10 shows the flow stress curve obtained for the same specimen. The maximum flow stress is 1121 N/mm² which is at 2.62 mm. The presence of a large number of grain boundaries results in the increase of hardness and flow stress.

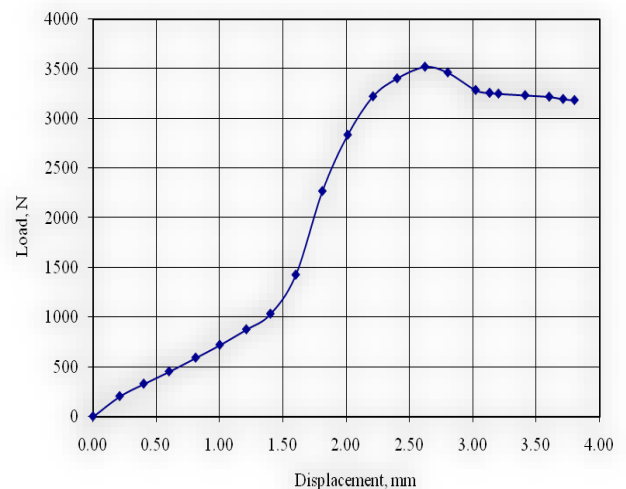

Figure 9. Load Vs Displacement curve for pure Copper with heat treatment

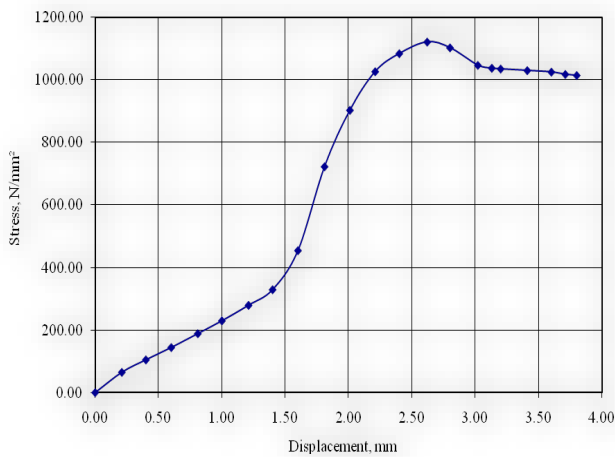

Figure 10. Stress Vs Displacement curve for pure Copper with heat treatment

CONCLUSIONS

Development of the advanced micro manufacturing technologies like micro extrusion for fabrication micro parts has become an important issue. In this work, a successful fabrication of micro extrusion assembly is done and extrudates up to 3.8 mm are obtained. The effect of grain size on deformation load an vvariation of strengthening effect are observed in different copper specimens. The grain size effect on material strengthening in deformation process is related to the characteristic of the grain boundary and the grain boundary is more strained and harder when compared to the grain interior. Further the experimental investigation results could be summarized as follows:

- ≡ The load versus displacement plot for micro extrusion is similar in nature to that of conventional extrusion
- ≡ Beyond certain dimensions, factors that can be ignored with conventional machining suddenly play a big part in micro manufacturing
- ≡ An effective ejection system is essential to prevent material lost due to chipping while removal of the extrudates.

It is also expected that further research activities, necessary to understand the micro and macro aspects of deformation

ACKNOWLEDGMENT

The authors wish to thank the Management of PSG College of Technology (PSGCT), Coimbatore and the Centre for Advanced Tooling and Precision Dies, PSGCT for the facilities and support provided by them to carry out this research work.

REFERENCES

[1] Geiger M, Kleiner M, Eckstein R, Tiesler N, Engel U: *Microforming*, CIRP Ann Manuf Technol 50(2), 445–462, 2001

[2] Engel U, Eckstein R: *Microforming—from basic research to its realization*, J Mater Process Technol, 125, 35–44, 2002

[3] Qin Y: *Micro manufacturing Engineering and Technology*, Elsevier, 2010.

[4] Takatsuji N, Hosokawa S, Dohda K, Makino T: *Influence of friction behavior on forming of micro-parts by forward–backward extrusion of 6063 aluminum alloy*, International Forum on Micro Manufacturing Gifu, Japan, 2010

[5] Krishnan N, Cao J, Dohda K: *Study of the size effects on friction conditions in micro extrusion—part I: micro extrusion experiments and analysis*, J Manuf Sci Eng Trans ASME 129 (4), 2007, 669–676, 2007

[6] Chinesta F, Cueto E, Engel U, Rosochowski A, Geißdörfer S, Olejnik L: *Microforming and nanomaterials, Advances in Material Forming*, Springer, Paris, pp 99–124, 2007. doi:10.1007/978-2-287-72143-4_7

[7] Akhtar Razul Razali, Yi Qin: *A Review on Micro-manufacturing, Micro-forming and their key issues*, Procedia Engineering, 53, 665 – 672, 2013

[8] Fu M W, Chan W L: *A review on the state-of-the-art microforming technologies*, Int J Adv Manuf Technol, 67:2411–2437, 2013

[9] Xuehua Dong, Fei Chen, Shan Chen, Yang Liu, Zhiying Huang, Hui Chen, Shanfei Feng, Lei Zhao, Zhilin Wu, Xiping Zhang: *Microstructure and micro hardness of hot extruded 7075 aluminum alloy micro gear*, Journal of Materials Processing Technology, 219, 199–208, 2015



ACTA Technica CORVINIENSIS
BULLETIN OF ENGINEERING

ISSN:2067-3809

copyright ©

University POLITEHNICA Timisoara, Faculty of Engineering Hunedoara,
5, Revolutiei, 331128, Hunedoara, ROMANIA

<http://acta.fih.upt.ro>