



1. Gábor FEKETE

## THE NEW UNIFIED THEORY OF ENERGY (UNITHE) SUPPORTING CERN MEASUREMENTS AND ITS UTILIZATION IN ENERGY TRANSFORMATIONS

<sup>1</sup>. Contact Energy System Ltd., HUNGARY

**Abstract:** The science can be treated on novel scientific bases by recognizing the elementary block together with the working mechanism– and the system technique of our Universe. With the help of new scientific bases, which are supported by the CERN measurements, its axioms can be derived and all the experimental results can be well explained. Understanding the controlling property of the field energy gives the opportunity to make it use of work as a new energy source.

**Keywords:** Energy quantum with dipole property, pondusian and non–pondusian energy system, new source of energy, CERN

### INTRODUCTION

Nowadays an intense interest is taken in novel, clean and environmental–friendly energy sources due to several urgently important reasons. These kind of reasons e.g. the world running out of the traditional energy supplies, which sources also heavily encumber the nature, or the problem of global warming–up, but also the nuclear power not an alternative because its dangerousness. By this time the technology has reached a highly advanced level, which enables us to study physical effects that can't be described using the well–known scientific theories (e.g. effects of hadrons collisions, nanotechnological, astrophysical). The purpose of the new field theory which is a novel energy theory, would be to compensate the scientific gaps. The space of our existence, the Universe can be divided into two parts in terms of energetically, so we can distinguish the pondusian energy system, which system show mass property, and the non–pondusian energy system, which doesn't show mass property. So a pondusian energy system with a  $m$  body mass volume is always encompassed inside and out within the non–pondusian energy system, which is also known as field energy. The elementary block of the non–pondusian energy system is the energy quantum with dipole

properties, which can be named as the „God particle” after Leon Lederman. The further thinking of the above described leads to a new field model, which creates the bases of a new scientific theory, that can point out a novel way of energy transforming thus a new energy source. As far as I know there are several field theories were born so far, but as my factual knowledge none of them provide a fully nature–like, realistic model. The field model of the new field theory has been proven nature–like when describing physical phenomena.

### THE NEW FIELD MODEL, THE PONDUSIAN AND NON–PONDUSIAN ("FIELD ENERGY") ENERGY SYSTEMS IN THEOREM STYLE

1. Our space of existence, the Universe is filled up with field energy.
2. The elementary block of the field energy is the energy quantum with dipole properties.
3. The non–pondusian energy systems (field energy) are created by the zero spin field of the space arisen from the infinite freedom building blocks.
4. The pondusian energy systems are originated by the energies that have spin. These energy systems show mass property, and they are

created from the basically zero spin field and found in that too.

5. The pondusian or more known as matter like energy with mass property systems are constituted by periodic functioning formations, which are creating a pulsing oriented field – the source of gravitation. The pulsing oriented field is transmitted by the zero spin energy field.
6. The excited pondusian energy system shows dipole property at macro scale (e.g. magnets, electric charge separation), which external oriented field or also referenced as external aura can be used to produce physical work. This physical work is done normally by the non-pondusian energy system, which always regularize statically and dynamically to the minimum energy. (keep in mind the 3<sup>rd</sup> definition!)
7. The energy source of the aura is the field energy, and the catalyst is the excited material. So the field energy can be utilized as a new drainless energy source, which works nature-like, following the rule of non-pondusian energy system.

The science can be treated on a novel basis with the help of introducing the non-pondusian energy systems as field energy. This can help to redefine certain fields of science in order to make it more complete. For this reason two new concepts are introduced, one is the contact energy field vector  $\bar{E}_K$ , which helps the mathematization of the interaction of pondusian systems, the other is a new interaction type, – the 5<sup>th</sup> – called inertial interaction, which is required to describe the interaction function between pondusian and non-pondusian systems. For example we can utilize the principle of minimum energy in the interaction of the magnetic fields of today's excellent performing, high quality and strong industrial magnets. With regard to the conventional naming and notation used by the description of electrical machines, we describe the one excited magnetic field with a  $\bar{\phi}$  – flux field vector, and the other magnetic field with a  $\bar{I}$  – current field vector. Their interactions with each other can be described with the  $\bar{E}$  – contact energy field vector, which is handled as a potential energy, so the equation arise as the following:

$$\bar{E} = (\bar{\phi} \cdot \bar{I}^*) \cdot (-j) = T - j \cdot E_0 \text{ (VAs)},$$

where  $T$  – is the mechanical energy,  $E_0$  – is the energy of the contact field. These energy components are regulated by the field energy always to the minimum energy.

With the help of introducing the inertial interaction, the ether-, relativity- and quantum theory can be unified in the UNIFIED THEORY OF ENERGY (UNITHE), so the strong, weak, EM and the gravitational interactions can be handled and re-constructed on the same bases. Thereupon the axioms of today's physical science, like inertia, gravity, magnetic or electric field, aren't axioms anymore, because they can be described using the UNITHE. With this nature-like model there is no part of the space without energy or matter, in another way said vacuum doesn't exist! The newest results in science, like particles with the speed above the speed of light [4] and information propagations can be explained nature-like. Consider a classical experiment, a moving electric charge in an electric field. If an electric charge is accelerated by a constant electric field then the acceleration of the charge will be decreasing over time. Explanation according to Theory of relativity (Einsteinian theory): since the volume of the electric charge and the volume of the electric field strength are constants, therefore the accelerating force is constant also, so after Newton  $\bar{F} = m_e \cdot \bar{a} = \text{constant}$  which is only true if the volume of  $m_e$  is increasing when the volume of  $\bar{a}$  is decreasing. The result of the experiment supports the theory of relativity. Explanation according to the UNITHE: the change of the momentum can be written after Newton axiom in the following form  $\bar{F} = d(m_e \cdot \bar{v})/dt = \text{constant}$ , furthermore  $\bar{F}_I = \bar{v} \cdot (dm_e/dt)$  and  $\bar{F}_E = m_e \cdot (d\bar{v}/dt)$ . The  $\bar{F}_I$  denotes the change of the internal aura force system of the electric charge with volume  $m_e$  and velocity  $\bar{v}$ . In order to the volume of the mass and charge of the particle be constant, the  $m_e$  shouldn't change, therefore  $\bar{F}_I = 0$ . But the force required to change the external aura of the  $m_e$  mass by  $d\bar{v}$  (otherwise said the contact energy band switch) is increasing as the speed  $\bar{v}$  is higher but still the  $d\bar{v}/dt = \text{constant}$ . So consequently if  $\bar{F}$  and  $m_e$  are unchanged and  $\bar{v}$  is

increasing, then  $d\bar{v}/dt = \bar{a}$  should decrease. In this manner we have got the same result as in the Einsteinian physics, but in this theory system the volume of the particle  $m_e$  doesn't changed. If a mass moves with a mass  $m_e$  and with  $\bar{v} = \text{constant}$  speed, then it is converting the space in front of it to its aura shape by a  $\bar{F}_E^*$  restraining force, but the same time the field energy reconverts with  $-\bar{F}_E^*$  propulsive thrust the space behind the mass. Therefore the energy is unchanged of the mass with volume  $m_e$  and with  $\bar{v} = \text{constant}$  speed. Furthermore due to the invariableness of the mass energy  $m_e(v) = m_{0e}$ , which arises relatively with zero speed. Concisely the momentums of the bodies are caused by the band switch (the difference of propulsive thrusts and restraining forces) of the contact energy band, which band is a function of velocity.

#### THE FIELD ENERGY, THE ORIENTED FIELD, FIELD INTERACTIONS AND THEIR MODELING

The elementary block of the field energy is: the energy quantum with dipole property. Its main feature is that it fills up our space of existence with equivalent probability and with equivalent energy density probability, so creating the zero spin energy field, the Universe. Furthermore the field energy can be modeled in an elementary volume with an extremely small and infinitely large by the piece of dipole energy quanta, which summarized energies is equal to unit in the elementary volume. But a unit volume contains infinite elementary volumes so the non-pondusian energy of a unit volume is infinitely large. (The matter originates also from the field energy by rearrangement of the energy! {see definition 4<sup>th</sup>, further explanation later}).

The oriented field is: a dipole like arranged, non-pondusian energy system, which shows energy difference in the space! For example the magnetic or electric fields are oriented fields, their systems technologies only differ at the excitation mode of the material.

The model of field energy: the field energy - which is dipole like, has infinite d.o.f. energy with zero spin, fills up the space with equivalent probability and with equivalent energy density, and also

allows for the energy spectrum of the oriented field - can be modeled in a unit volume as energy quanta with discrete frequency values, ranging zero to infinite with an unit energy value (Figure 1).

Thus:

$$P_i [W] = 1 \cdot f_i [Ws/s] = 1/T_i [Ws/s] \Rightarrow P(T) = 1/T.$$

The energy of a unit volume:

$$\int_0^{\infty} P(T) \cdot dT = \int_0^{\infty} \frac{1}{T} \cdot dT = \left[ \ln \frac{\infty}{0} \right] = \ln \infty = \infty [Ws],$$

which gives the result of the original definition!

Where  $f[\text{Hz}]$  - frequency,  $T[\text{s}]$  - time of period, a  $P[W]$  - power.

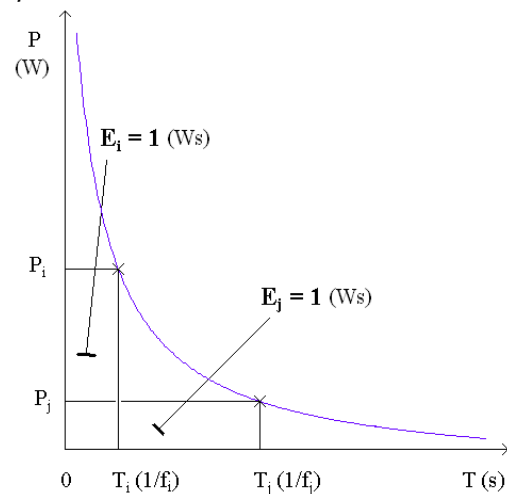

Figure 1. The power-time-frequency spectrum of the field energy containing unit energy

The gravitational field: is the simultaneous oriented field (the periodic pulsating oriented field and the oriented field) of the material (pondusian energy system) and the excited material. The feature of the oriented field of the material, that it is a periodic pulsing oriented field, which is created by the periodically moving elementary particles in the same structure. As model like, in the half period of the pulsing the north spectrum is the determinant, but in the other half the south spectrum is determinant in the same inertial system. Therefore when one mass has north spectrum then the other has south spectrum. (It attracts always! Always the larger mass synchronizes on self the lesser mass! In respect of two masses e.g. the Sun - Earth relation the attracting force presents itself relating to the Earth in the direction of the line between mass centres, perpendicular to this the force in the going direction namely the tangential force - from the

spectral's phase angles  $\omega$ , and the rotation providing moment! This all arises from the force system of the pulsating synchronized field's contact energy.) For this reason the gravitational field between the bodies is a periodic pulsing oriented field which is created by the bodies! An analogue electric model of the excited material's oriented field is shown on the Figure 2, where  $I$  is the intensity of the oriented field,  $t^-$  is the time of the resultant negative effect,  $t^+$  is the time of the resultant positive effect.

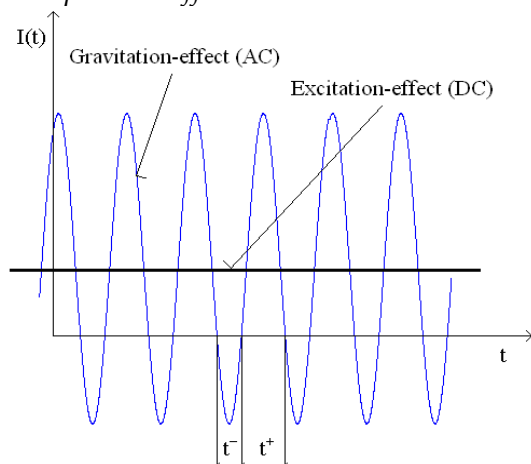

Figure 2. The analogue electric model of the oriented field of excited material

Explanation of mass and its measurement: The ether existed in Maxwell's time (1831 - 1879) which was filling up the space but was basically totally unknown. Today it is called as black energy, vacuum energy, zero-point energy, Higgs-field, field energy, non-pondusian energy system, etc. But Einstein was also a master mind in his time (1879 - 1955) and he would like to prove the existence of ether with experiments. The results of his efforts were unsuccessful in this matter.

Afterwards came the ingenuity of Einstein with the statement of non-existing ether (this is still not proved today yet!). The outcome of the declaration is the theory of relativity. The mass-energy equivalence in equation form by Einstein:

$$E = m \cdot c^2 \quad (Ws = Nm = J = VAs),$$

in case of a photon:  $E_f = m_f \cdot c^2$ .

Bring back and fill-in the space with the unknown ether on the foundation of the new energy theory, considering it as a non-pondusian energy system. Place a photon into the space which is now filled-in with field energy and write down the mass-

energy equivalence equation for the photon  $E_f$  after Einstein:

$$E_f = m_f \cdot c^2 = E_{Kf} = (m_f \cdot c) \cdot (c) = E_{0f}.$$

It can be easily seen from the equation, that the energy of the photon equals with the contact energy  $E_K$ , which was introduced before. Now the contact energy can be written as a scalar, because of the same direction of velocity, furthermore the index "f" refers to the photon. As opposed to the relation  $E_f$  the relation of  $E_{Kf}$  implies the energy of the two energy systems that are in contact. More precisely the contact between the photon's energy spectrum or aura that has "c" speed and "m<sub>f</sub>" mass and the energy spectrum or aura of the field that has "c" speed and "f<sub>c</sub>" frequency. This contact between energy systems are always controlled by the field energy to the minimum energy level. (Referring back to the inertial interaction.) So as the newly introduced field theory the activation energy required to emerge a photon from a source and the conservation of its energy is done by the field energy by providing its moving with "c" speed. In this manner the movement of the photon with the speed of light is the steady state of it. The  $E_{0f}$  refers to the constancy of  $m_f = m_{0f}$ . The controlled energy, which is provided by the field energy, can be expressed in equilibrium as  $E_{field}^c = E_{kinetic, foton}$ . Therefore the energy arisen from the contact of oriented fields:

$$E_{Kf} = E_{field}^c + (1/2) \cdot (m_{0f} \cdot c) \cdot (c) = E_{field}^c + (1/2) \cdot (I_f) \cdot (c).$$

The featuring energies (energy values change, with respect to the notation in literature) written up with oriented field contacts:

$$\begin{aligned} E_{kinetic} &= (1/2) \cdot m \cdot v^2 = (1/2) \cdot (I') \cdot (v) [Nm], \\ E_{rotational} &= (1/2) \cdot \Theta \cdot \omega^2 = (1/2) \cdot (L') \cdot (\omega) [Nm], \\ E_{coil} &= (1/2) \cdot L \cdot I^2 = (1/2) \cdot (\phi) \cdot (I) [VAs], \\ E_{capacitive} &= (1/2) \cdot C \cdot U^2 = (1/2) \cdot (Q) \cdot (U) [VAs], \\ E_{potential} &= m \cdot g \cdot h [Nm], \end{aligned}$$

where the (1/2) multiplier is left because there is no change in the aura!

Without showing the proof [1], the mass, denoted with "m" in the mass-energy equivalence formula by Einstein, has an aura in the new UNITHE. Furthermore it has only one kind of a value, which is independent from its speed, it can be called as the

stationary mass  $m_0$ , that value changes only when the inner aura changes. Ergo the value of  $m_0$ , that is measurable, is arisen by the interaction of the pondusian and non-pondusian energy systems. If we re-think the working mechanism of the mass-spectrometer, then the following can be said. The required volume of inertial energy is measured during the accelerating process of the pondusian mass  $m$  in the non-pondusian energy field. So the inertia of the mass  $m$  is measured, which value is the same as the Einsteinian stationary mass. Due to the formerly mentioned the following can be stated that not the speed is limited of a material moving in space, but its acceleration!

The explanation of mass defect at nuclear fusion: let the  $M(A,Z)$  be the mass of the atom nucleus with  $A$  nucleon number and  $Z$  atomic number,  $m_p$  the mass of the proton,  $m_n$  the mass of the neutron. Due to the principle of the conservation of matter:

$$M(A,Z) + \Delta m = Z \cdot m_p + (A-Z) \cdot m_n.$$

The  $\Delta m = \text{mass defect}$ , which is explained as the followings, energy is liberated and left the nucleus as a certain mass during the fusion, which results of a new atom. Because of mass-energy equivalence of the theory of relativity:

$$\Delta m \cdot c^2 = E_{\text{binding}}.$$

As the new field theory: there is only energy transformation during the fusion of protons and neutrons, there isn't any reduction in mass nor energy liberation! As the new field theory the basic properties of a particle like its mass, charge and spin, need to be extended with its periodic pulsing oriented field and also with its oriented field, another said with its inner and external aura! The  $m_p$  takes part in the combination process with its periodic pulsing oriented field together with its oriented field, which exists due to the excitation of the particle. In the same way takes part in the process the other particle  $m_n$  with its periodic pulsing oriented field. When they are close enough, then their periodic pulsing oriented field get synchronised to each other which results in a strong gravitational interaction so forming a nucleus with  $M$  mass. From the point of energy the resulting new periodic pulsing oriented field of the nucleus (external aura) is as less as the inner

gravitational interaction absorbs in contact energy  $E_K$  form. The oriented field of the proton remains unchanged, because it didn't get in interaction with anything! Relating the theories:

$$\Delta m \cdot c^2 = E_{\text{binding}} = E_K [VAs]!$$

The second equality not only statutory, but shows its nature-like consentaneity.

The process of neutron decay and its explanation: the process is discussed by the Feynman diagram. The starting and resulting masses of the decay process:

$$m_{\text{neutron}} > m_{\text{proton}} + m_{\text{electron}} + m_{\text{antineutrino}}.$$

During the decay a  $W^-$  boson emerges, which mass  $m_{W^-} \cong 80 \cdot m_{\text{neutron}}$ . The laws of the classical physics don't permit this! As the theory of quantum mechanics, it is a resonance mass where the particle isn't on the mass shell, that is described by a Breit-Wigner distribution. The dispersion, deviation of the mass distribution and the lifetime of the particle can be calculated using the principle of uncertainty.

The physical phenomenon is well described by these mathematical methods, but the questions why it is happening so, and what the cause of the event is, are remaining still unanswered! Higgs tried to explain the experimental results. He claimed it is because the tricky Higgs mechanism. Introducing a new field, the Higgs field, it appears that the properties of vacuum are changing! If the " $W^-$  (and also  $Z^-$ )" bosons meet with a neutral Higgs field during their travel in vacuum, then they "feel resistance". Thus becoming mass. This is the only explanation until for the question why have the two types of bosons mass. The final evidence would be if the Higgs particle without spin has been found. This is being researched in all of the recently built particle accelerators (e.g. CERN). Analysing the neutron decay on the novel field theory basis, we can see a neutron state which has a low value energy difference in energetically stabile and labile state of motion. Placing a neutron  $m_{\text{neutron}}$  into a natural varying (disturbing) external oriented energy field the neutron will suffer aura change in its labile energy state and will be converted into a stabilized state of motion with mass of  $m_{\text{proton}}$ . The consequence of the aura change is the change of state of the field energy of contact

field, which means a transition into a dynamic turbulent state, that has spin. Thus this is making the non-pondusian energy system – the dipole energy quanta – to operate on periodical way, which periodic pulsing oriented field (aura) shows inertia that can be measured as  $m_{W^-}$  mass. While the turbulent energy combination with  $m_{W^-}$  mass can't get into stabile state because  $\Delta E < E_{critical}$ , therefore it reverts into its zero spin state. The energy combinations with oriented field (electron, antineutrino), that are within the unstable  $m_{W^-}$  mass energy combination, are remaining still unchanged, because of the energy conservation principle and energy equilibrium provided by the non-pondusian energy field. At last the antineutrino will be with his pair the energy of the zero spin field. Remarks: The zero spin field researched by Higgs, could be defined the non-pondusian energy system or field energy! If energy difference change occurs from the interaction of pulsing oriented fields and that energy difference is above the critical volume " $\Delta E > E_{critical}$ " in the near surroundings of a point in the space, then periodic pulsing oriented field could be created at that location. In this way matter could be created from the field energy (e.g. born of black holes etc.)! If a random energy difference occurs that difference is more above the critical value  $\Delta E >> E_{kritikus}$ , and the self-energizing process turns into steady state, then continuous energy transformation maintained so the non-pondusian energy system (field energy) as an energy source will be radiated mostly in matter form (like photons) by the source field. This is the way as stars and our Sun could be born and work! During the process while the self-excitation gets into a steady state form could pour out system of substances which could be remain in interaction through gravitation. Returning back to the Higgs-boson, likely it doesn't exist in its imagined form, but masses like  $W^-$  and  $Z^-$  bosons and so their differing series could be arisen. The most recent news (2012. July) about Higgs boson discovery and its measurement data prove my statement. Since there are more Higgs-bosons than the physicist thought. It comes up that not only one type of Higgs-boson exists, which refers to the "shadow world" of particles namely the super symmetrical

particles [10]. These thoughts are allowable in the point of view of today's scientific knowledge. The mathematical formulations also can be established, but the natural processes, my 33 years experimental experience and the experimental data of particle colliders all support the new field theory UNITHE. On this new basis it can be clearly seen, that during the collision of  $a+b$  particles not only  $a+b$  components emerge, but their contact field, precisely their non-pondusian energy transformed into periodical form can appear also. These forms can be detected which are determined by the state of motion of  $a+b$  particles with a collision probability (that is to say the probability result of the reactions  $a+b \rightarrow c+d+\dots$  etc.), this is done so the conservation of energy principle and the energy equilibrium are continuously secured statically and dynamically by the rearrangement of the non-pondusian energy system.

As in the recent literature [8] (2009) about theory of relativity is stated generally:

$$m = \frac{m_0}{\sqrt{1 - \frac{v^2}{c^2}}},$$

where:  $m_0$  = stationary mass,  $c$  = speed of light.

But the author of the book also states that the  $m = m_0$ , with referencing on the experiments of the CERN. So after the book, the phenomenon which was described in the previous expression is caused by the time dilation. The before says are well harmonizing in the official axiom system of the relativity theory. Furthermore the author states that the ether doesn't exist with referencing to the Michelson-Morley experiment. The result of the before mentioned experiment is that the relative speed of the ether to the Earth is zero. Developing the train of thought, then the ether doesn't exist. The result of this kind of thinking is that the experiment supports Einstein's theory. I am delighted to learn that the result also should be a zero relative speed ether, field energy, non-pondusian energy system when reconsidering the experiment on the basis of the new field theory. The new unified theory of energy is also able to construe nature-like the recent scientific experiments [9]. The experiences of experiments are shortly: if there are electron pairs created with

more kilometres distance among them, change of the state of one electron results in a change in the other electron's state in a way that the change in the second electron occurs more faster than the speed of light. Other experiment, if we study electron(s) that are able to interfere, and using an electron detector than the interfering phenomenon stops. These couldn't be explained on today's scientific bases. The phenomena which were mentioned before or the paper [9], couldn't be explained in a nature-like way using today's scientific axioms, we can get only deductive but unknown results in a point of view of nature. Analysing the phenomena and their process that take place in the nature, it seems that there isn't any physical event that couldn't be explained nature-like with the new theory of energy.

The UNITHE could be the basis of the future's science, which premonitory sign is stated for my pleasure by the erudite and experienced academician Péter Lévai [11]: "The new physics is coming. Either the new particle fits into the Standard model or not, the story is far from its end. Since the Standard model only describes the visible matter and its interaction. The 96% of the Universe is constituted by a matter, which is only sensible through gravitational interaction, so it falls beyond the Standard model's range. The job of LHC will be the exploration of this new physics. "The story just begins. Our self-confidence is at right place after these results, we can start off to the next 15 years." - said Lévai." Peter Higgs and Francois Englert shared the 2013 Nobel Prize in physics for the Higgs mechanism and theory of the Higgs boson, but it remains a problem that the expected one type of Higgs boson was not found! On the basis of my 33 years research background it can be stated: the theory of relativity is irrefutably true on the bases of today's science!

The new unified theory of energy also proves irrefutably true on the new bases! But! The theory of relativity is unable to explain the most fundamental physical phenomena, but the new unified theory of energy is able! So! The theory of relativity should be adjusted to the nature! The unified theory of energy is nature like!

## PRACTICAL RESULTS OF THE NOVEL FIELD THEORY

### A\*/ The energy controlled drive of an asynchronous motor with frequency inverter:

In the followings the contact energy field vector is denoted with  $\bar{E}$  („K" index is left).

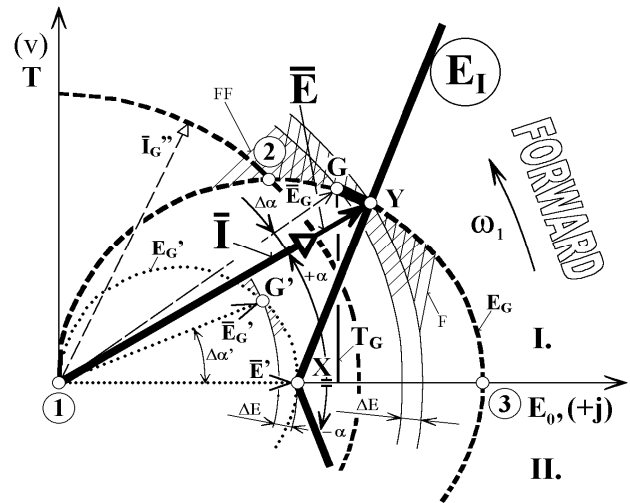

Figure 3. The combined contact energy and its control diagram of the induction machine  
On the Figures 3-7 a four quarter drive are shown that was developed by me at Retronic prozess-systemtechnik GmbH, (West)Germany [7]. During the work three patents were born. The rotational speed is controlled by the system without neither any feedback nor computation. But the control of the rotation is more dynamic and more accurate as in the conventional solutions. The optimal way of using the energy is controlled as in the living systems, by the fault signal of contact energy  $E_F$  (Figure 4). The control function  $E_I$  which can be adapted to the system:

$$E_I = \sqrt{2} \cdot I \cdot \sqrt{\left(\frac{B-A}{B-2A+I}\right)^Z}$$

where the A, B, Z parameters should be set after the Figure 4 in order to adapt to a specific system. The main parts of the system (Figure 4): IFIMD induction motor drive frequency inverter, EM energy model, ERU energy reference unit, EC energy controller, CC current controller, SFSCU frequency of the axis seeking and follow-up unit, RFI frequency of the rotor adjuster. In 1995 a research engineer from the Siemens stated that this system is twenty - twenty-five years before the industrial demands. This statement is still true today.

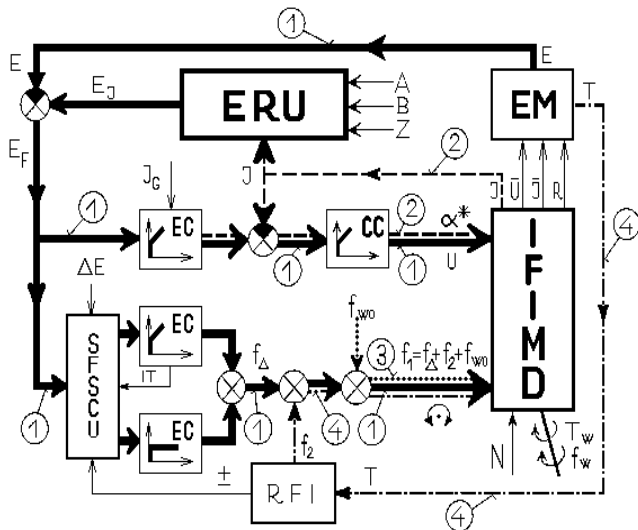

Figure 4. The current based energy control (CBEC)

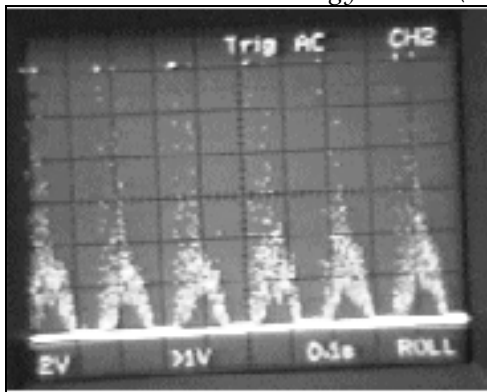

Figure 5. The combined contact energy and its control diagram of the induction machine



Figure 6. The dynamic breaking of the induction motor

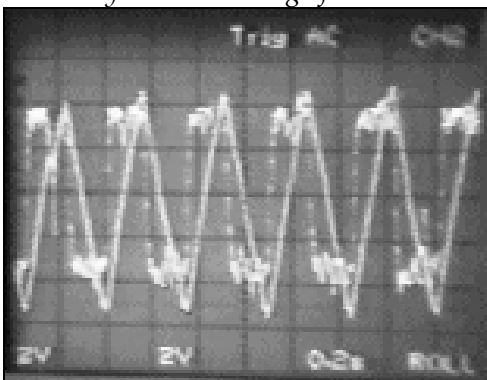

Figure 7. The signal of torque and rotation

**B\*/ The mechanically constrained new type of energy transforming:**

An example is shown on the Figures 8–10, which shows a method for transforming the  $\bar{E} = \bar{E}_{xy}$  contact energy of magnetic fields in a mechanical way. The I is a planetary moving magnet, and II is a ring magnet. Additional details of the device can be found in the literature [5]. This device has become a patent in 2009 [3].

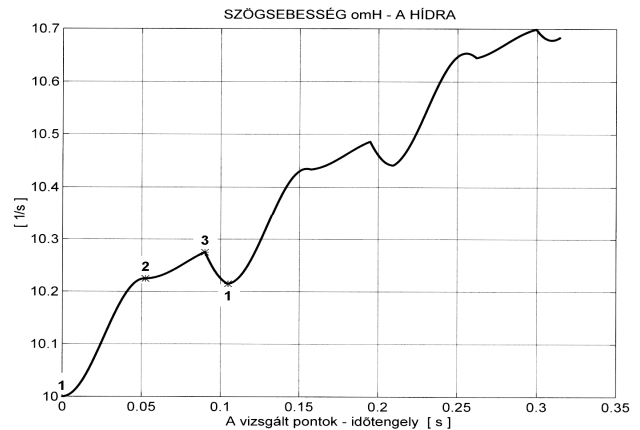

Figure 8. The angular velocity of bridge

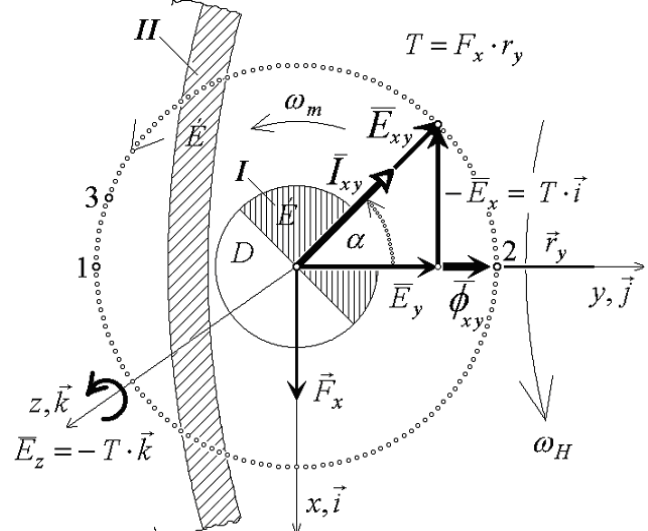

Figure 9. The contact energy

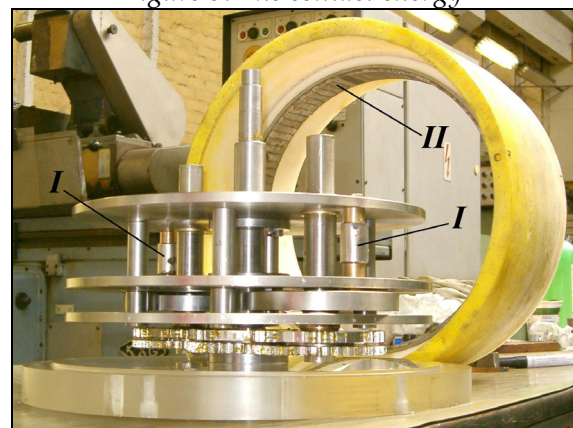

Figure 10. The device



**C\*/ The new way of energy transforming, that is mimicking the nature and free in move:**

The simplest electric device, the transformer is also an energy controlled system. The control – the correction of the fault of the field due to the load – is made by the oriented field, which is described with  $\bar{\phi} [Vs]$ . This non-pondusian energy field controls always as the following function:

$$\bar{\phi}(t) = \int_0^t \bar{U}_k(t) \cdot dt = L \cdot \bar{I}_g(t).$$

The  $\bar{U}_k [V]$  is the constraint voltage of the generator,  $\bar{I}_g [A]$  is the response current of the exciting constraint,  $L [H]$  is the inductivity of the system. In this energy transforming device (and in all of our devices) only the energy transportation can be accomplished by the field energy. In the energy transforming devices of the future, the field energy would also produce work, so appearing a new source of energy that is undrainable, which could control with infinite power. The announcement for an European patent has been made of a high power energy transforming device on April 2011 [1] and the international announcement with priority reference has been made in 2012 [2], which was published in October 2012.

The previously mentioned A\*, B\*, C\* type of energy transformations and their set of efficiency: the energy transformation is shown on the Figure 11. and the efficiency set is shown on Figure 12. The methods that are valid for A\*, B\* processes, and are discussed in [6]. The generalized and re-worked version (Figures 11–12.) handles the energy transmission of the A\*, B\*, C\* methods together, and shows how the efficiency will conform as the UNITHE if considering the work capacity of the non-pondusian energy system.

Our machinery couldn't be described as closed systems considering the new field theory the UNITHE, because of the material like pondusian systems are located in the non-pondusian systems, which permeates through everything. This is the interferer element of the gravitation also, so the gravitation couldn't be shielded, or remember the Michelson–Morley experiment, which also proves the correctness of the new field theory  $\Rightarrow$  mass couldn't be transferred by the pondusian energy

system because of its system technique, it only can guarantee the conservation and equilibrium of energy!

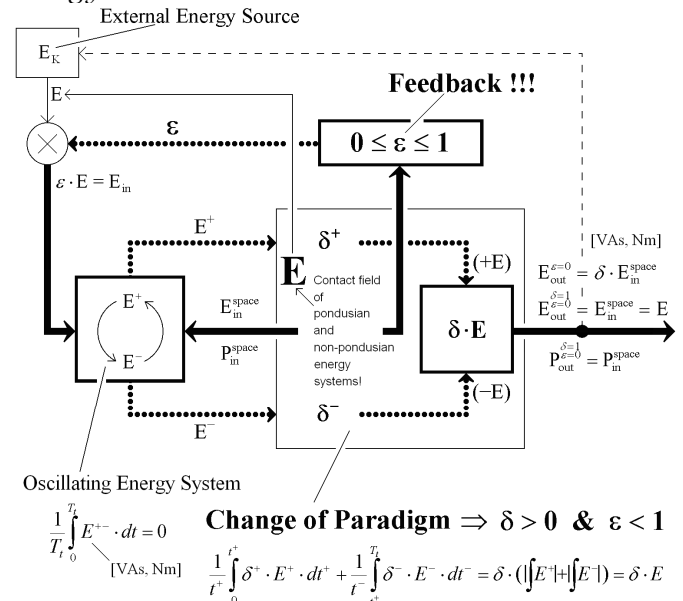

Figure 11. The model of A\*, B\*, C\* type energy transformation processes without losses

Considering the energy transformation processes (Figure 11) the determinant energy is the E, which energy arises from the contact relation of the fields. The mechanics is attacked by the force system of the before mentioned energy. The mechanical construction determines that in which direction it is going to work and what comes out on the output. It is important to notice, that the Universe' static and dynamic energy equilibrium, the conservation of energy, the transmission of information and the energy source of work all provided by the controlling laws of non-pondusian energy system for the equipments and for the vital and non-vital systems. The contact energy E feedback is taken account by a feedback factor ε on the input of model on Figure 11. We can mind our periodically working systems as an alternating energy. The forms of these for different working types (A\*, B\*, C\*) are determinant. In the future we are not going to deal with the conventional losses.

The characteristic energy transmission mechanism of the appliances are shown on Figure 11. Where:

- E contact energy,
- $T_i$  one cycle time of the magnetic contact,
- ε contact energy feedback coefficient,
- δ contact energy rectification coefficient,
- + magnetic moving support impact emergence,



with this a new energy source, which actually always existed!

### SUMMARY

Analyzing the information recently has come to light, it seems like there is no such physical phenomenon which could not be defined nature-like by the Unified Theory of Energy (UNITHE). In the reflectance of the results, the new energy source could definitely be the basis of future energy management. The new field theory is entirely supported by the CERN measurements and by the results of engineering science. The Higgs-boson as a new particle proves Higgs theory. The non-pondusian energy systems have the same and more functions as the Higgs-boson plus it can translate all today's axioms like gravitation, planetary motions, etc. which research has just begun in the particle accelerators. The new field model and the new field theory open the door for reinterpretation of the interactions on common bases.

### ACKNOWLEDGEMENTS

Thanks and acknowledgements to all who have supported me during my 33 years of researches. Thanks to our forefathers, who have put down the principles of the current sciences through their researches, thanks to the particle physicist, who are constantly performing the required experiments for me and through their publications they give chance for proving the correctness of my theory Thanks to my colleague and inventor partner, Csaba Pintér, project and sales director owner, for his really precious support provided in the latest period. Thanks for the fulfilled works to the Contact Energy System Ltd. (Kapcsolati Energia Rendszerek Kft.) and to the Pinter Works (Pintér Művek), to my colleague Dr. Arnold Rónaföldi for his valuable advices and thanks to professor Dr. Károly Jármái and my colleagues Levente Szalontai and János Fenyősy for their help in publishing this paper.

### REFERENCES

- [1.] Fekete, G., Pintér, Cs.: Method and apparatus for exploiting interaction energy of magnetic fields, European patent application, Number: E11462006, 2011. (published in October 2012).
- [2.] Fekete, G., Pintér, Cs.: Method and apparatus for exploiting interaction energy of magnetic fields, International patent application, Number: PCT/HU2012/000029, 2012. (published in October 2012).
- [3.] Fekete, G.: Process for moving "inducted voltage"-less rolling part placed in magnetic field and equipment for realisation of process, University of Miskolc, Hungarian patent: HU 226 570 B1, 2009.
- [4.] Fekete, G.: The New Unified Theory of Energy (UNITHE) and Practically Useful Results. 12<sup>th</sup> International Conference on Energetics - Electrical Engineering, ENELKO 2011, Cluj, 6-9 October 2011, Proceedings, pp: 28-37.
- [5.] Fekete, G.: Rectifying of Contact Energy in New Systems. 16<sup>th</sup> International Conference on Electrical Drives and Power Electronics (EDPE 2007), High Tatras, Slovakia, 2007, Proceedings: Power Generation and Transmission, Full paper on CD-ROM.
- [6.] Fekete, G.: Study of Transfer of Contact Energy of Industrial Magnets in a New Magnetic Power Machine. 16<sup>th</sup> International Conference on Electrical Machines, ICEM 2004, Cracow - Poland, 2004. Proceedings, pp: 503-504, Full paper, CD-ROM.
- [7.] Fekete, G.: A New Energy Controlled Current Source Inverter Fed Induction Motor Drive, 9<sup>th</sup> International Conference and Exhibition on Power Electronics and Motion Control, EPE-PEMC 2000, Kosice, Slovak Republic, 2000. Proceedings, Vol. 7., pp: 130-134.
- [8.] Hraskó, P.: A relativitáselmélet alapjai. Tankönyv, Typotex Kiadó, 2009, ISBN 978 963 279 027 5
- [9.] internet: <http://www.idokep.hu/hirek/quantum-radar-delayed-choice-eraser> (site checked: 2014. 03. 03.).
- [10.] internet: <http://www.origo.hu/tudomany/20120712-higgs-bozon-standard-modell-szuperszimmetria.html> (site checked: 2014. 03. 03.).
- [11.] internet: <http://www.origo.hu/tudomany/20120704-az-ev-vegere-derulhet-ki-hogy-valoban-a-higgsbozont-fedezteke.html?beusz> (site checked: 2014. 03. 03.).

**ACTA Technica CORVINIENSIS**  
BULLETIN OF ENGINEERING

**ISSN:2067-3809**

copyright ©

University "POLITEHNICA" Timisoara,  
Faculty of Engineering Hunedoara,  
5, Revolutiei, 331128, Hunedoara, ROMANIA  
<http://acta.fih.upt.ro>